



MONITOR SYSTEM

INSTALLATION &
OPERATION
INSTRUCTIONS
FOR

ULTRA-8

EIGHT TANK
CAPABLE
DISPLAY
PANEL

*Congratulations
on your purchase!*

You have selected the best holding tank monitor system available. With proper installation you will enjoy years of accurate and trouble free operation.



1850 North Arthur
Pocatello, ID 83204
1-208-233-7290

You are a valued customer and we look forward to answering any questions you may have regarding the installation or operation of this system.

This manual covers installation, adjustment and usage of the ULTRA-8 display panel.

TABLE OF CONTENTS

FEATURES	PAGE 2
INSTALLATION GUIDE	PAGE 3
CALIBRATION GUIDE	PAGE 8
TROUBLESHOOTING GUIDE	PAGE 9
PANEL CUSTOMIZATION	PAGE 12
WARRANTY INFORMATION	PAGE 13

SNAKE RIVER ELECTRONICS

ULTRA - 8 DISPLAY PANEL

FEATURES/IMPROVEMENTS

This panel includes a number of new features and improvements over our previous display panels, such as:

- 2 X 16 LCD display for tank designation, status and level.
- Tank level read-out is a 10-position bar graph.
- HI/LO/OK status indicator displayed for each tank.
- Simple user interface.
- Simplified push-button calibration with on-screen instructions.
- Panel independently checks all tanks every 2 hours.
- Red warning light to indicate when any tank is out-of-bounds (i.e., a waste water tank is too full or a fresh water tank is too low).
- Audible warning chirp sounds every 2 hours to indicate when any tank is out- of- bounds (audible alarm is automatically disabled at night)
- Panel can be used to monitor up to 8 separate tanks.
- This panel is designed to interface with all of our existing sensors allowing waste water, fresh water, in-tank rods and diesel fuel tanks to be monitored.

INSTALLATION GUIDE

This kit includes an Ultra-8 panel and wiring harness

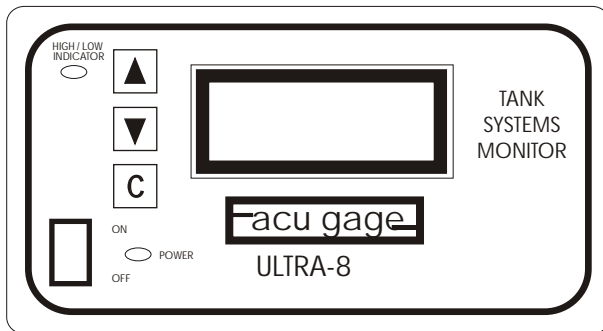

ONE
PANEL

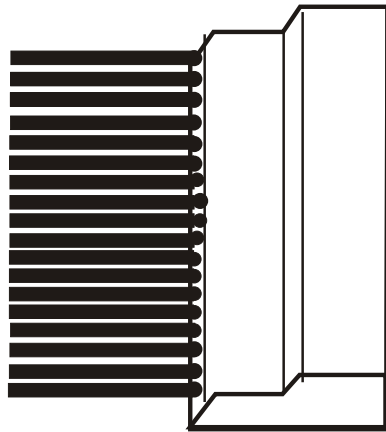

WIRING
HARNESS

Typical sensor kit (sold separately):

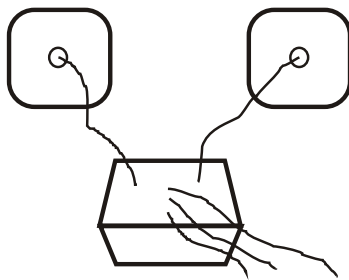

SENSOR
MODULE
(STYLE MAY VARY)

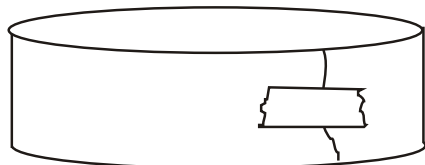

ONE ROLL
FOIL TAPE

If you purchased your sensor kit as an aftermarket kit, it may also include the following (refer to the owners manuals for the sensor(s) that you have purchased):

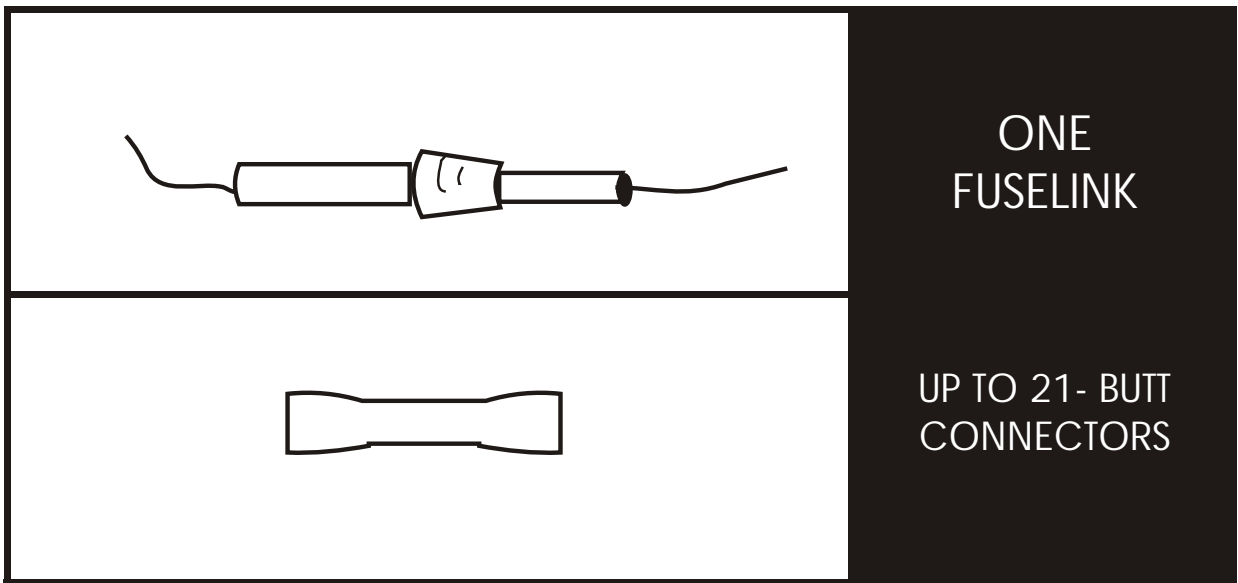

YOU WILL NEED TO PROVIDE:

- A. 18 Gauge Hookup Wire
- B. 4 Screws To Secure Panel

You will also need sensor kits (sold separately) appropriate for the type(s) of tanks you have in your vehicle.

STEP ONE:
Location and Installation of Monitor Panel

NOTE: READ CAREFULLY

Choose a panel location that is convenient to see and reach, and that does not interfere with drawers, cabinets, existing wiring, etc. In choosing a location you must also give major consideration to the fact that wires must be routed from the panel to the holding tanks. MAKE CERTAIN the proposed wiring routes are not blocked by the wall stringers or other structural supports.

REFER TO FIGURE #1 and cut the panel opening as indicated. The panel will attach to the wall with 4 screws (not included) at the corners. Do not attach the panel to the wall until all other installation, calibration and testing has been completed.

FIGURE #1
Panel Cutout

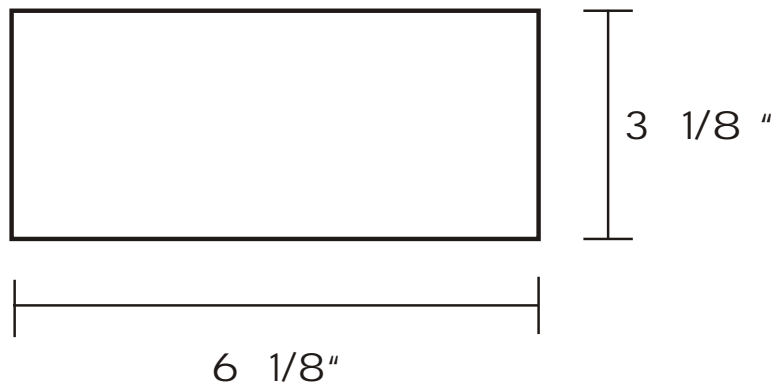

STEP TWO:
Install Sensors Onto The Tank(s)

Refer to owners manuals/installation guides for the types of sensors that you are going to be installing. Follow the instructions for all sensors to be installed then return to this guide for the completion of wiring to the Ultra-8 display panel.

STEP THREE: Wiring Installation

NOTE: READ CAREFULLY. DO NOT use staples or nails to secure wiring. Route wires so they do not interfere with storage areas and are away from potential sources of heat (oven, exhaust pipes, etc.). Due to the vast range of application possibilities it is not practical for us to include hookup wire in the kit. It is, however, commonly available and inexpensive. Use 18 gauge standard wire and make certain you have enough to make all connections.

The hookup wire is used to make connections to a 12 volt D.C. power source and for connecting the panel to the tank(s). After studying the wiring installation procedures, cut the hookup wires to required lengths, strip the insulation off all wire ends approximately 1/4" and use the supplied butt connectors to join wires between pigtail and modules.

A. Take time to study Figure #3 and the "HOOKUP GUIDE" on the following page. The first connections are made to wires 3 and 4 of the pigtail wire. IMPORTANT: The other ends of these wires must also be identified as 3 and 4 (use an adhesive sticker or masking tape). These wires are then routed to the holding tank and wire 4 will connect to the red module lead and wire 3 will connect to the blue module lead. Repeat this procedure for all attached sensor modules insulate the ends of any unused panel connector leads (except black and red) with electrical tape.

B. Refer to Figure #2 below and finish wiring by connecting wire 1 (red) to 12 volt D.C. Positive, then wire 2 (black) together with all black module wires to 12 Volt D.C. Negative. If you are using more than one module, use the larger wire nut to accommodate the extra wires. NOTE: it is recommended that the power wires (red and black) be hooked to a battery voltage source. The 0.5 amp fused link is wired in line on the red wire as shown in Figure #2.

If possible, avoid wiring to a convertor power source or to wires that power flourescent lights. This could result in electrical "noise" which may effect accurate panel readings.

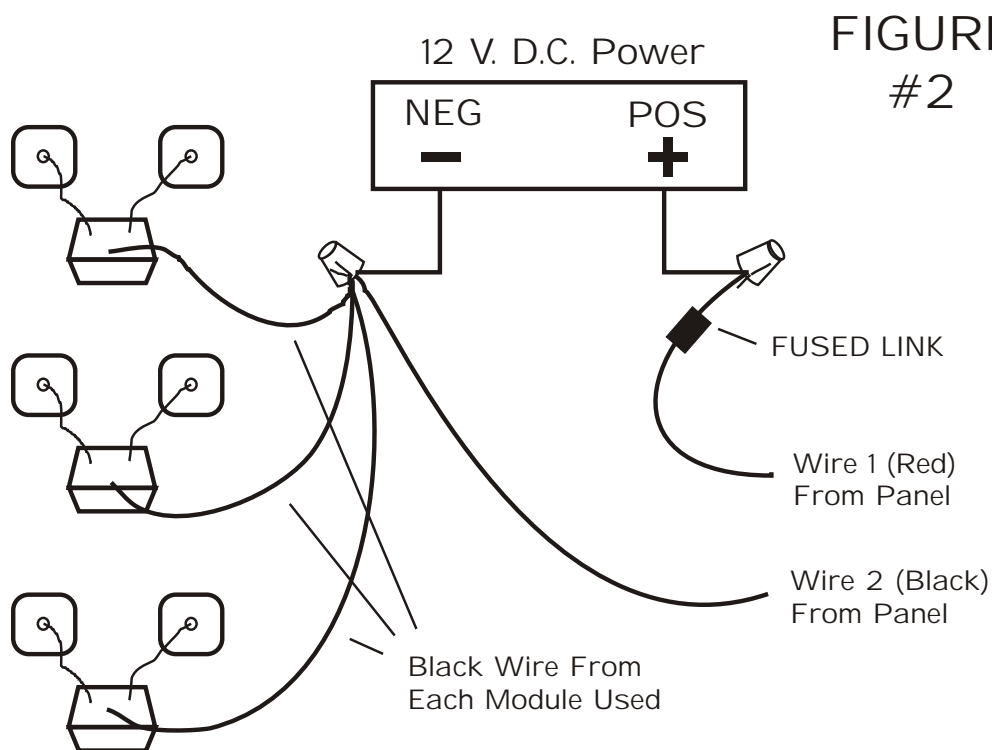
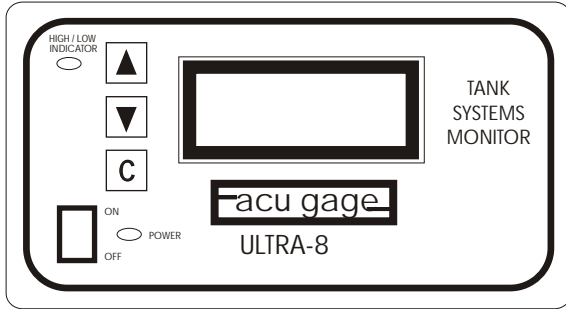
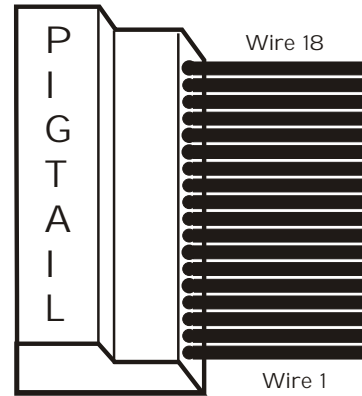

FIGURE #3



Panel



Panel Connector

COLOR CODE AND HOOK-UP GUIDE

<u>DESCRIPTION</u>	<u>PIGTAIL WIRE</u>	<u>MODULE WIRE</u>
TANK ONE	BLUE	BLUE
	PURPLE	RED
TANK TWO	YELLOW	BLUE
	ORANGE	RED
TANK THREE	GREEN	BLUE
	GREY	RED
TANK FOUR	BROWN	BLUE
	WHITE	RED
TANK FIVE	BLUE/WHIT	BLUE
	PINK	RED
TANK SIX	RED/WHITE	BLUE
	BLACK/WHITE	RED
TANK SEVEN	GREEN/WHITE	BLUE
	PURPLE/WHITE	RED
TANK EIGHT	BROWN/WHITE	BLUE
	ORANGE/WHITE	RED
GROUND - BLACK	12 VOLT - RED	

CALIBRATION GUIDE

When installation of the system is complete, it is necessary to calibrate each tank for empty and full. Tools are not required to perform calibration.

The first step is to empty the tank of fluid. Then scroll through the tanks using the up and down arrow keys until the tank desired is displayed. To calibrate this tank press the "C" key. The display will prompt you to press the up-arrow key for a full tank, the down-arrow key for an empty tank or the "C" key to end.



To calibrate the tank to empty, press the down-arrow key. Next, the display will read, "Are You Sure?" Press the up-arrow for "YES", or the down arrow for "NO"



By pressing the up-arrow the panel will read the current tank level and store it as empty.

To calibrate a tank for full, completely fill the tank with fluid. Follow the above procedure, except, press the up-arrow key for full when prompted. Repeat this procedure for all tanks attached to display panel.

If you calibrate the tank incorrectly (i.e., calibrate an empty point that is above the full point, or a full point below the empty point, or identical full and empty points), the monitor panel indicates this to you with an error message and prompts you to recheck the tank level and try again.

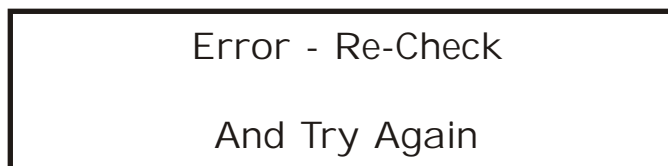

Note: (for Ultra-8 display panels manufactured after 11/01/02) if the above error message is encountered, default calibration values for empty and full are recorded in the memory of the panel. These values correspond to a sensor output of OVDC (zero) for empty and 3VDC for full. These values are identical to the initial values programmed into the display panel when it was first tested at the factory. This return to default values clears possible bad calibration data which might make the sensor channel difficult to properly calibrate (i.e.: an empty calibration value erroneously set with a full tank would otherwise prevent the setting of a proper full value until the empty point is set back to an appropriate empty value).

The return to default calibration values will be "in the ballpark" with regard to accuracy for most sensors, but for maximum accuracy empty and full calibration will need to be performed for a tank when the above error message is seen.

TROUBLESHOOTING GUIDE

Factors affecting accuracy of readings and calibration:

The unit should be calibrated with the vehicle as close to level as possible. Depending on where the sensor strips are located on the tank, the reading may be somewhat sensitive to the pitch of the vehicle (due to fluid sloshing either against or away from the sensor elements mounted to the tank wall). Keep this in mind when interpreting what otherwise might be a malfunctioning sensor or display.

Some tanks, particularly those mounted below the decks in boats, may be impossible to completely drain or may refill with a small amount of fluid after pumping out (due to fluid left in the drain plumbing, which may drain back into the tank). If you calibrated empty on such a tank when it was completely dry (as in a factory installation) it may read that there is some fluid in the tank even when pumped empty. If this is the case simply recalibrate the empty point after pumping out and allowing to "settle" to an actual "empty" level.

PROBLEMS & REMEDIES

Problem:

Panel does not appear to retain calibration values.

Possible cause:

Damaged memory chip

Test/remedy:

Turn main power switch off. Press in both up and down arrow buttons and while holding them in, turn the power back on. The panel will display the following:

FLASH MEM TEST IN PROGRESS

This indicates that the panel has entered a special diagnostic mode which tests the memory (do not turn power off to the panel until the test is complete or loss of one or more calibration values is possible).

If the test is a failure, the following is displayed:

FLASH MEM TEST MEM BAD : REPLACE

If the above message is displayed, contact Snake River Technical Support to arrange for the repair of your display.

If the test is successful, the following is displayed:

FLASH MEM TEST MEMORY GOOD

If the above message is displayed, the memory has checked out fine and the problem lies elsewhere. Try recalibrating the troublesome tank for empty and full. If this does not correct problem, contact Snake River Technical Support for additional instructions.

Problem:

Panel does not turn on with power switch.

Test / Remedy:

Check fuse on power wire. If bad, replace. Check that power and ground wires are properly attached. Repair, if necessary. If either or both of these do not fix the problem contact Snake River Technical Support for additional instructions.

Problem:

A tank channel always reads full, empty or never changes regardless of level of fluid in the tank.

Possible Causes:

- 1) improperly calibrated tank
- 2) damaged wiring between the display and sensor module
- 3) damaged or improperly installed sensor foil
- 4) damaged sensor module

Test/Remedy:

1) Recalibrate tank for empty and full and recheck. See following page for additional advice on resetting calibration values for a channel to factory default values.

2) Check all of the wire between the sensor module and the display panel. Check that all wires are attached properly and that there is no damage along the wire run (staples through wires are a common problem to look for). Repair any problems found and recheck.

3) Check that the sensor foil is installed according to the instructions in this book. Also check that there is nothing "shorting out" the sensor foils (i.e.: metal object touching both foils), or that a large metal object is too close to the foils. Finally, check that the white wires attached to the sensor module have not come unattached from the aluminum sensor foil. Correct any problems found.

4) If you have checked the wiring and sensor foil and nothing appears incorrect and if you have recalibrated the tank and it is still not reading correctly, the sensor module on the tank itself may be damaged. You can look at the live output from the module by turning off the panel, pressing and holding the "C" button and turning the panel back on. You will see a screen like this:



The 3 digit number at the lower left of the screen shows the sensor output of the channel identified on the top line of the screen (scroll up or down with the arrow keys until the tank you are interested in is displayed). The output for an empty tank should be between 000 and 50; a full tank should read between 150 and 200. If the readings do not change or are well outside of the values given here, contact Snake River Technical Support for additional instructions or to arrange for a replacement sensor module to be sent to you.

Problem:

A calibration value is entered which is incorrect on a sensor channel which is otherwise working normally (i.e. an empty calibration value which is too high or a full value which is too low).

Possible Causes:

1) improperly calibrated tank

Test/Remedy:

If practical to do so, drain the tank and set the empty calibration point then fill it and set the full.

If it is impractical to drain the tank and re-fill (i.e. a fuel tank), then the factory default calibration values for the troublesome tank can be re-set (Note: the following only applies to Ultra-8 display panels manufactured after 11/01/02).

By intentionally creating a calibration error (see page 8 in this manual) the firmware in the Ultra-8 display panel will record default calibration values for both empty and full in its memory. These values correspond to a sensor output of 0VDC (zero) for empty and 3VDC for full. These values are identical to the initial values programmed into the display panel when it was first tested at the factory. This return to default values clears possible bad calibration data which might make the sensor channel difficult to properly calibrate (i.e.: an empty calibration value erroneously set with a full tank would otherwise prevent the setting of a proper full value until the empty point is set back to an appropriate empty value).

Creating this error can be done by simply setting the full calibration value then immediately setting the empty calibration value (see calibration procedure on page 8 of this manual). By doing this, you are trying to set identical empty and full values which the Ultra-8 firmware will not allow, and you should see the error message depicted on page 8. Once the error message is displayed the factory default calibration values for that tank are now set.

The return to default calibration values will be "in the ballpark" with regard to accuracy for most sensors, but for maximum accuracy, empty and full calibration for the tank should be done as practical to do so.

PANEL CUSTOMIZATION

ULTRA-8 Panel custom design options:

- Start- up splash screen can be customized with your own text message (limited to 2 lines each 16 characters long).
- 1 to 8 tanks can be monitored.
- Tank designations can be customized to match your configuration using a two-word tank designation for each tank. These designations can be up to six characters per word. (examples: Fresh Water, Waste Water, Fwd Waste, Aft Waste, etc.).
- Normal tank monitoring occurs every 2 hours; however, timing can be changed to read in as short a time as 1 minute or as long as 4 hour intervals.
- Audible alarms can be enabled or they can be disabled for any tank or disabled completely if audible alarms are not desired. Audible alarms can also be enabled or disabled at night.

Call SNAKE RIVER ELECTRONICS or refer to the enclosed customization order form or visit our web page, WWW.SNAKE-RIVER.ORG, for more details.

LIMITED WARRANTY

Snake River Electronics warrants this product to be free from defects in material and workmanship under normal use for a period of one year from the date of purchase. This includes the replacement of parts and the labor involved to repair or replace the part.

This warranty is valid for the original retail purchaser and is NOT TRANSFERABLE. Keep original sales receipt and validate warranty by filling out and returning the enclosed warranty registration card. Proof of purchase is required to obtain warranty.

This warranty does not cover damages resulting from accident, misuse, abuse, improper installation, or lack of reasonable care. If the product was damaged in transit, file a claim with the carrier.

Snake River Electronics is not responsible for incidental or consequential damages resulting from installation or use of product.

Except as provided above, no warranty or affirmation of fact, expressed or implied, is made or authorized by Snake River Electronics and Snake River Electronics' liability in all events is limited to the purchase price.

This warranty gives purchasers specific legal rights. Purchasers may also have rights which vary from state to state. Certain aspects of disclaimers are not applicable to consumer products; e.g. (A) Some states do not allow the exclusion or limitation of incidental or consequential damages, so the above limitation or exclusion may not apply to you. (B) Also, some states do not allow the exclusion or limitations on how long an implied warranty lasts, consequently the above limitation may not apply to you. and copyright by law, during the period of this warranty, any implied warranties or merchantability of fitness for a particular purpose applicable to consumer products purchased by consumers, may not be excluded or otherwise disclaimed.

PROMPT DISPOSITION: Snake River Electronics will make a good faith effort for prompt correction or other adjustments with respect to any Acugage Monitor System which proves to be defective within warranty.

WARRANTY PROCEDURE: Should you discover a defect in the Acugage Monitor System during the warranty period, YOU MUST FIRST CONTACT SNAKE RIVER ELECTRONICS AT 208-233-7290. At our discretion we will request the part be sent to us or we may direct you to the nearest authorized service center for repair. Parts returned to Snake River Electronics must be postage paid, and include check or money order for \$700 to cover the cost of return shipping and handling. RETURN TO: Snake River Electronics, 1850 North Arthur Pocatello, ID 83204.